

LS 321



Operating Instructions

Identification

Customer service

Precisa Gravimetrics AG
Moosmattstrasse 32
CH-8953 Dietikon
Tel. + 41-44-744 28 28
Fax. + 41-44-744 28 38
email service@precisa.ch

<http://www.precisa.com>

Refer to our website for information about local customer service centers and details of their addresses.

Copyright

These operating instructions are protected by copyright. All rights reserved. No part of the operating instructions may be reproduced, processed, duplicated or published in any form by photocopying, microfilming, reprinting or other process, in particular electronic means, without the written agreement of Precisa Gravimetrics AG.

© Precisa Gravimetrics AG, 8953 Dietikon, Switzerland, 2013

1 Overview

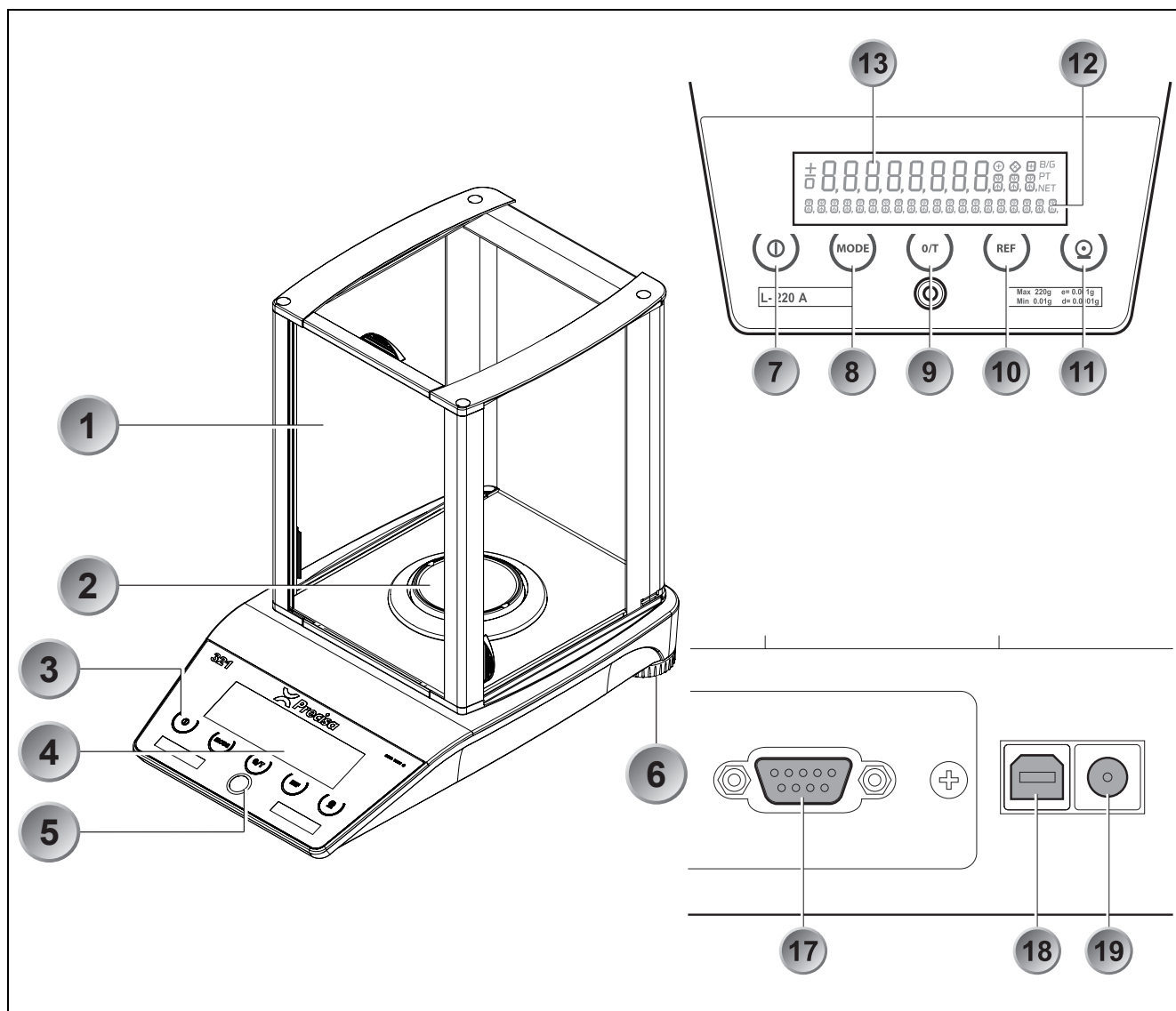

No.	Description	No.	Description
1	Draft shield	11	PRINT key
2	Weighing pan	12	Info display
3	5-key control panel	13	Measurement display
4	Display	14	see chapter 5 "Below-balance weighing"
5	Levelling bubble	15	see chapter 5 "Below-balance weighing"
6	Adjustable feet	16	see chapter 5 "Below-balance weighing"
7	ON / OFF key	17	Serial interface, DB9 Female
8	MODE key	18	USB device connector for connection to PC
9	O / T key	19	Connecting socket for power adaptor
10	REF key		

2 Inspection and assembly

Inspect delivery for complete supply immediately on unpacking all components.

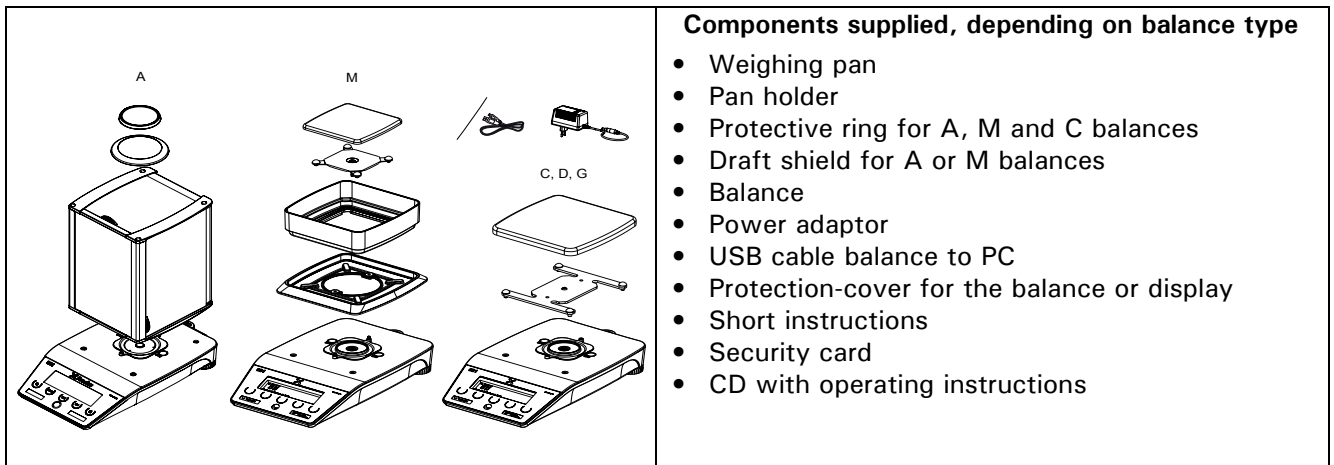

The balance is delivered in partly dismantled condition. Assemble the individual components in the following sequence:

- Install the draft shield as well or the protective ring
- Place the weighing pan in position
- Insert the power adaptor cable plug into the socket at the rear of the balance.

! NOTE

All parts must fit together easily. Do not apply force. Customer Service will be pleased to help you with any problems.

■ 3 Firmware and serial number

3 Firmware and serial number

After a reconnection of the balance to the mains and switching on for the first time the serial number as well as the firmware will be showed in the display.

Display	Remark
3141592	Serial number: 3141592
00,00 P07 D01	Firmware: D01-0000.P07 D01: Hardwarecode 0000: Version P07: Release

4 Data and parameters

The balances are divided into five main-groups SM, A, C, D, G and M. The letter in the name corresponds to the design specification (e.g. SM = semi micro, A = analytical balance, M = Milligramme balance) the number before it corresponding in each case to the maximum allowable load (in grammes).

The allowable weighing range, the calibration value and the readability of the balance are printed on the type plate and sales plate sticked to the casing and are therefore not presented here.

The following applies to all balances:

- **Mains connection**
 - 115 - 230V (+ 15/-20%); 50 - 60Hz
- **Power consumption**
 - without peripheral appliances 18.0 VA
- **RS232/V24 Interface**
- **USB device Interface**
- **Allowable ambient conditions**
 - Temperature: 5°C ... 40°C
 - Relative humidity: 25%... 85%, non-condensing
- If you have any questions on the technical data or require detailed technical information on your balance, please contact your Technical Representative.

5 Below-balance weighing

Objects which, because of their size or shape, cannot be put on the scale, can be weighed by means of below-balance weighing.

Proceed as follows:

- Turn off the balance.
- Remove the weighing pan and the pan holder than turn the balance up side down.
- Remove the screw (14) on the underside of the balance.
- Hang the hook for weighing below (available as an accessory, see chapter 6 "Accessories") into the aperture (16) of the now visible metal casting (15).
- Place the balance over an opening.
- Replace the pan holder and the weighing pan.
- Level the balance (see chapter 9.6 "Levelling")
- Switch on the balance.
- Hang the object to be weighed on the hook and carry out the weighing.

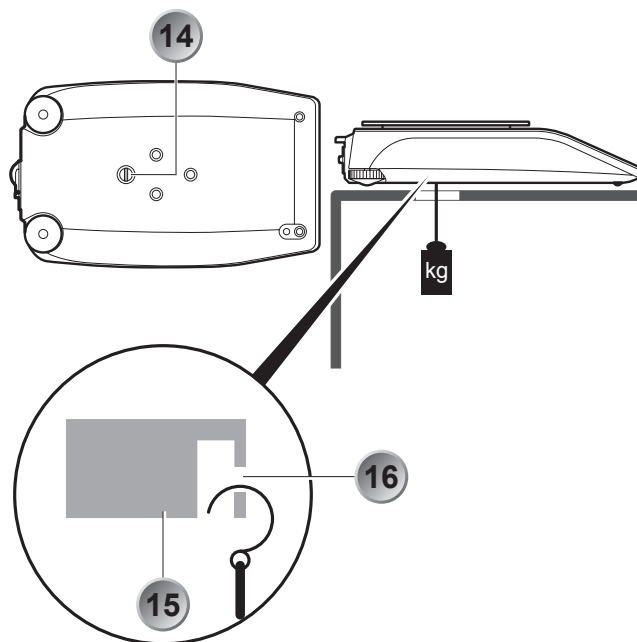

WARNING

Take care that the hooks used for the below-balance weighing are stable enough to hold the goods which you wish to weigh.



NOTE

Take care that no dirt or moisture can get into the balance with the weighing pan removed. After completing the below-balance weighing, the opening in the floor of the balance must be closed again (dust protection).

■ 6 Accessories

6 Accessories

Accessory	Article number
Draft shield mg, glass with cover	320-8504
Density kit for 0.01mg and 0.1mg balances Container size Ø 75mm, height 100mm	350-8636
Density kit for solids only (w/o Glass body and Hook) for 0.01mg and 0.1mg balances Container size Ø 75mm, height 100mm	350-8537
Glass body 10ccm for density determination of liquids	350-7054
Downholder for samples with density < 1 g/cm ³	350-7194
Animal weighing bowl complete for 0.01g, 0.1 and 1g balances	350-8551
Diamond weighing pan	350-8322
Hook for weighing below the balance	350-8527
Dust cover for the whole balance, set of 20 pieces	350-8686
Data cable DB9 Male / DB9 Female (PC), 1.5m	350-8672
Data cable DB9 Male / DB25 Male (Printer), 1.5m	350-8673

Additional SmartBox® Applications, Precisa BUS accessories, further special accessories and options on demand.

■ Contents

1	Overview	2	11.2	Language-function	20
2	Inspection and assembly	3	11.3	Selecting the weight unit	21
3	Firmware and serial number	4	11.4	Print functions.....	21
4	Data and parameters	4	11.5	Calibration functions	22
5	Below-balance weighing	5	11.6	Weighing mode	22
6	Accessories	6	11.7	Interface-functions.....	24
7	Your balance	10	11.8	Date and time	24
7.1	Introduction	10	11.9	Password protection	25
7.2	Correct use of the balance	10	11.10	Anti-theft encoding	25
7.3	Conformity	10	11.11	Keyboard settings.....	25
7.4	Technical data.....	10	11.12	Precisa BUS	25
7.5	Useful tips on the Operating Instructions	10	12	Working with the application menu	26
8	Safety	12	12.1	Structure of the application menu	26
8.1	Representations and symbols	12	12.2	Selecting a working program.....	26
8.2	Safety recommendations	12	12.3	Changing application / weighing mode	27
9	Set up	13	12.4	Application "UNITS"	27
9.1	Unpacking the balance	13	12.5	Application "COUNT"	27
9.2	Transport and shipping	13	12.6	Application "PERCENT"	28
9.3	Storage	13	12.7	Application "NET-TOTAL".....	28
9.4	Choosing a suitable location.....	13	12.8	Application "ANIMAL"	29
9.5	Connecting the balance to the mains..	14	12.9	Application "DENSITY"	29
9.6	Levelling.....	14	12.9.1	Density determination "Solid on bottom mode".....	30
9.7	Calibration of the balance	14	12.9.2	Density determination "Solid in air mode" 30	
9.8	Dual Range and Floating Range balances	15	12.9.3	Density determination "Liquid mode" .	30
9.9	Standardized balance	15	12.9.4	Density determination "Solid porous mode" 30	
10	Modes of operation and operating	16	12.10	Application "DIAGNOSTICS"	30
10.1	Switching on the balance	16	13	Special operating keys	32
10.1.1	Firmware and serial number	16	13.1	The Tare key «0/T»	32
10.2	Auto-Standby Mode.....	16	13.2	The Print key «PRINT»	32
10.3	Setting and storing the configuration..	16	14	Data transfer.....	33
10.4	Significance of the two main menus ..	16	14.1	Connection scheme	33
10.5	Activating the two main menus.....	16	14.2	Remote control-commands	34
10.5.1	Activating the configuration menu	16	14.2.1	Examples for the remote control.....	34
10.5.2	Activating the application menu.....	17	15	Practical examples	35
10.6	How the menu control operates.....	17	15.1	Changing the configuration menu	35
10.6.1	Operating in the weighing mode	17	15.1.1	Setting the choice of language	35
10.6.2	Display.....	18	15.1.2	Setting the Weight unit	35
10.7	Password protection of the menus.....	18	15.1.3	Setting the Print functions	35
10.8	Anti-theft encoding.....	18	15.1.4	Activation of password protection	36
11	Working with the configuration menu	20	15.2	Selection of an application program ...	36
11.1	Structure of the configuration menu... 20		15.2.1	Setting for Counting by weighing	36
			16	Maintenance and servicing.....	37
			16.1	Calibration	37
			16.1.1	External calibration by means of ICM .	37

16.1.2 External calibration with freely selectable weight37

16.1.3 Internal calibration38

16.1.4 Automatic calibration38

16.2 Firmware update38

16.3 Cleaning38

16.4 Error messages39

16.4.1 Notes on correcting faults39

17 Menu trees40

17.1 Configuration menu tree40

17.2 Application menu tree42

17.3 User menu tree - to save or load settings
42

7 Your balance

7.1 Introduction

The balances are high-quality electronic precision balances and developed to operate simple and functional. The versatile weighing programs allow you to use these balances not only for simple weighing procedures but also in a simple manner for carrying out various weighing applications such as, for example, percentage- or component counting weighings and document the measurements obtained accurately and unequivocally. Virtually all models can be delivered in weights and measures approved.

The most important basic production features of the Precisa balances include:

- Simple-to-use multifunction control panel
- Large and bright display with multi-lines
- Anti-theft encoding with four-figure numerical code
- Storable user-configuration (UMM User Menu Memorized)
- ICM-Autocalibration (intelligent calibration mode)
- USB device interface for data transfer to PC
- RS232/V24 serial interface for data transfer to PC or printers
- ISO- and GLP-compliant reporting of results of measurements
- Capacity and residual tare display
- Various application programs:
Piece counting, Percentage weighing, Animal weighing, Density and lot others
- Appliance for below-balance weighing

7.2 Correct use of the balance

The balance may only be used for the weighing of solid-materials and of liquids filled into secure containers. The maximum allowable load of the balance must never be exceeded, otherwise the balance may be damaged.

In using the balance in combination with other appliances as well as with appliances produced by other manufacturers, the current regulations for the safe use of the relevant attachments and their application in accordance with instructions must be observed.

7.3 Conformity

The balance has been manufactured and tested in accordance with the standards and recommendations set out in the certificate of conformity in the delivered brief instructions manual.

The power adaptor produced for the operation of the balance and intended exclusively for this application, complies with the electrical protection class II.

7.4 Technical data

The most important technical data of the balance are mentioned in the delivered brief instructions manual. If you have any questions on the technical data or require detailed technical information on your balance, please contact your Technical Representative.

7.5 Useful tips on the Operating Instructions

Precisa balances are simple and functional to operate.

Nevertheless, you should read through these operating instructions in their entirety, so that you can make optimal use of the full potential and the diverse possibilities of the balance in your daily work.

These operating instructions contain guidance in the form of pictograms and keyboard diagrams, which

should help you in finding the required information:

- Key names are presented in quotation marks and are accentuated by printing in semi-bold script: «**ON/OFF**».
- In the explanation of the operating steps, the appropriate display for the current operating step is shown for clarity at the left alongside the list of operating steps:

Display shows

LANGUAGE ENGLISH

SPRACHE DEUTSCH

LANGUE FRANCAISE

List of the Operating steps

- Press «**MODE**» button repeatedly until “LANGUAGE ENGLISH”, “SPRACHE DEUTSCH” or “LANGUE FRANCAISE” appears in the display.

8 Safety

8.1 Representations and symbols

Important instructions, which involve safety, are highlighted with the appropriate action:

 DANGER
Warning of a possible danger, which can lead to death or to serious injuries.

 WARNING
Warning of a possibly dangerous situation, which can lead to less severe injuries or damage.

 NOTE
Tips and important rules on the correct operation of the balance.

8.2 Safety recommendations

- When using the balance in surroundings with increased safety requirements the corresponding regulations must be observed.
- The balance may only be used with the power adaptor supplied exclusively for use with this balance.
- Before plugging in the power adaptor, make sure that the operating voltage stated on the power adaptor agrees with the mains voltage. If not, please refer to the Customer Service.
- If the power adaptor or its cable is damaged, the balance must immediately be disconnected from the electricity supply (pull out the power adaptor). The balance may only be operated with a power adaptor in perfect condition.
- If there is any reason to believe that it is no longer possible to operate the balance without danger, the balance must immediately be unplugged from the electricity supply (pull out power adaptor) and secured against inadvertent operation.
- In carrying out maintenance work, it is essential to heed the recommendations in chapter 16.3 "Cleaning".
- The balance must not be operated in an area subject to explosion risks.
- Take care when weighing liquids that no liquid is spilt into the inside of the balance or into connections on the rear of the equipment or the power adaptor.
If liquid is spilt on the balance, the latter must immediately be unplugged from the mains electricity supply (pull out power adaptor).
The balance may only be operated after it has first been re-checked by a Service technician.
- The operating instructions must be read by each operator of the balance and must be available at the workplace at all times. The balance may only be used for the weighing of solid-materials and of liquids filled into secure containers and for animal weighing and density determinations. The maximum allowable load of the balance must never be exceeded, otherwise the balance may be damaged.
- When using the balance in combination with other appliances, the current regulations for the safe use of the relevant attachments and their application in accordance with instructions must always be observed.

9 Set up

9.1 Unpacking the balance

The balances are delivered in an environmentally-friendly package, specifically developed for this precision instrument, which provides optimum protection for the balance during transportation.

! NOTE

Retain the original packaging in order to avoid transportation damages when shipping or transporting the balance and to allow the balance to be stored in the best conditions if it is out of operation for an extended period.

In order to avoid damage, attention must be given to the following points when unpacking the balance:

- Unpack the balance carefully. It is a precision instrument.
- When outside temperatures are very low, the balance should first be stored for some hours in the unopened transport package in a dry room at normal temperature, so that no condensation settles on the balance when unpacking.
- Check the balance immediately after unpacking for externally visible damage. If you should find transport damage, please inform your Services representative immediately.
- If the balance is not to be used immediately after purchase but only at a later time, it should be stored in a dry place where fluctuations in temperature are as low as possible (see chapter 9.3 "Storage").
- Read through these operating instructions, even if you already have experience with balances, before you work with the balance and pay attention to the safety recommendations (see chapter 8 "Safety").

9.2 Transport and shipping

Your balance is a precision instrument. Treat it with care.

Avoid shaking, severe impacts and vibration during the transportation.

Take care that there are no significant temperature fluctuations during the transportation and that the balance does not become damp (condensation).

! NOTE

The balance should preferably be dispatched and transported in the original packaging to avoid transportation damage.

9.3 Storage

If you would like to take the balance out of service for an extended period, disconnect it from the electricity supply, clean it thoroughly (see chapter 16.3 "Cleaning") and store it in a place which meets the following conditions:

- No violent shaking, no vibrations
- No significant temperature fluctuations
- No direct solar radiation
- No moisture

! NOTE

The balance should preferably be stored in the original packaging, since this provides optimum protection for the balance.

9.4 Choosing a suitable location

The balance location must be chosen in such a way as to guarantee perfect operation of your balance, so

■ 9 Set up

that the allowable ambient conditions and prerequisites are met and maintained:

- Put the balance on a solid, firm and preferably vibration-proof, horizontal base
- Make sure that the balance cannot be shaken or knocked over
- Protect from direct solar radiation
- Avoid drafts and excessive temperature fluctuations

! NOTE

With difficult conditions (where the balance may be easily shaken or subject to vibration) the balance can nevertheless provide accurate results through suitable adjustment of the stability control (see chapter 11.6 "Weighing mode").

9.5 Connecting the balance to the mains

The following safety recommendations must be observed when connecting the balance to the mains:

! DANGER

The balance may only be operated with the power adaptor supplied.

Check before connecting the power adaptor to the mains supply that the operating voltage stated on the balance or on the power adaptor agrees with the local mains voltage.

If the operating voltage is not the same as the mains voltage, the balance or the power adaptor must on no account be connected to the mains supply. Contact the Customer Service.

9.6 Levelling

To function properly, the balance must be precisely horizontal.

The balance is fitted with one spirit level and two adjustable feet for level-control, with the aid of which it is possible to compensate for small height differences and/or unevennesses in the surface on which the balance is standing.

The two screw feet must be adjusted so that the air bubble is precisely in the centre of the sight glass of the bubble level.

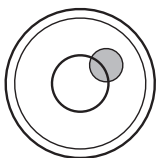

Incorrect

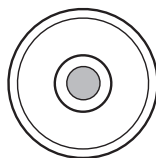

Correct

! NOTE

In order to get exact measurements, the balance must again be carefully levelled after each relocation.

9.7 Calibration of the balance

! NOTE

Make sure the balance has been connected to mains at least for one hour for class II balances or for 3 hours for class I balances before the first weighing or any calibration.

Since the Earth's gravity is not the same everywhere, each balance must – in accordance with the underlying physical weighing principle – be adjusted to compensate for the gravity at each location. This adjustment process, known as "calibration", must be carried out on initial installation and after each subsequent relocation. In order to get exact measurements, it is recommended moreover, that the balance should also be calibrated periodically.

! NOTE

The balance must be calibrated on initial installation and after every relocation.
If you work in accordance with "Good Laboratory Practice GLP" observe the prescribed intervals between calibrations (adjustments).

Calibration is effected in the configuration menu. Depending on the balance model, this may be done externally, internally or automatically (see chapter 11.5 "Calibration functions").

With the aid of the "Intelligent Calibration Mode" the balance can itself determine the size of the calibration weight, which enables an exact calibration with different size weights (in 10 g, 50 g, 100 g and 500 g steps, depending on implementation).

9.8 Dual Range and Floating Range balances

With the Dual Range balances, weighing is always first carried out in the fine range, which is 10 times more precise. When the fine range is exceeded the balance switches automatically into the coarse range.

The Floating Range balances have a fine range (10 times more precise), which moves over the entire weight range. By pressing the tare key «0/T» the fine range can be called up as often as required over the entire weight range.

9.9 Standardized balance

The standardized balances are provided with the EC/OIML certification or meet the local standardization regulations.

The balance range and certain functions of the weighing output differ from the standard program in the case of the standardized balances – in accordance with the EC/OIML provisions.

! NOTE

If a circle appears in the main-display of a standardized balance, the indicated value is unstandardized.
In balances of class (1) the circle also stands for the warm-up phase.
Your Customer Service will be happy to assist you at any time if you have any questions on the standardization of the balance or on working with standardized balances.

10 Modes of operation and operating

10.1 Switching on the balance

- Press «**ON/OFF**» to switch on the balance.

The balance carries out a self-diagnosis in order to check the most important functions. After completion of the start-up process (approximately ten seconds) "Zero" appears in the display.

The balance is ready for operation and is in the weighing mode.

10.1.1 Firmware and serial number

After a reconnection of the balance to the mains and switching on for the first time the serial number as well as the firmware will be showed in the upper display, see also Chapter 10.1 "Switching on the balance".

Display	Remark
3141592	Serial number: 3141592
01,00 P01 D01	Firmware: D01-0100.P01 D01: Hardwarecode 01,00: Version P01: Release

10.2 Auto-Standby Mode

The balance is equipped with an Auto-Standby mode, which can be activated or deactivated in the configuration menu. If the Auto-Standby mode is activated, the balance automatically switches to Standby some time after the last weighing or key operation (current-saving function).

The delay before switching to Standby is defined in the configuration menu (see Chapter 11.6 "Weighing mode").

- Press any button or put on a weight in order to switch the balance from the Standby mode back to the weighing mode again.

10.3 Setting and storing the configuration

- Press «**ON/OFF**», to switch on the balance.
- Continue to hold down the «**MODE**» and the «**0/T**» button during the start-up process, until the desired configuration appears on the display and then release the button:

"LOAD FACTORY CONFIG.": Load factory configuration.

"LOAD USER CONFIG.": Load user configuration.

"STORE USER CONFIG.": Store present configuration as user configuration.

10.4 Significance of the two main menus

The balance has two main menus available: the configuration menu and the application menu.

The basic-program of the balance is defined in the **configuration menu**. With this, you can either work with the basic-configuration programmed ex-works, or define and store a user-configuration adapted to your specific needs.

In the **application menu**, you define a working program, which is suited to the specific weighing problem.

10.5 Activating the two main menus

10.5.1 Activating the configuration menu

- Press «**ON/OFF**» to switch on the balance.
- Continue to hold down the «**MODE**» button during the start-up process (approximately 10 seconds), until the currently set language appears.
- Now you can change the configuration menu.

10.5.2 Activating the application menu

- After the start-up process has finished, press **«MODE»** until "SET APP. ..." appears on the display. You are now in the application menu.

10.6 How the menu control operates

The configuration menu and the application menu each have a main path and up to two sub-paths in which the parameters for the different function programs of the balance are defined.

Moving in the menu path:

- **«MODE»**-short: In path to the right or start input.
- **«MODE»**-long: In path downwards.
- **«PRINT»**-button: In path to the left (in main path exit menu).

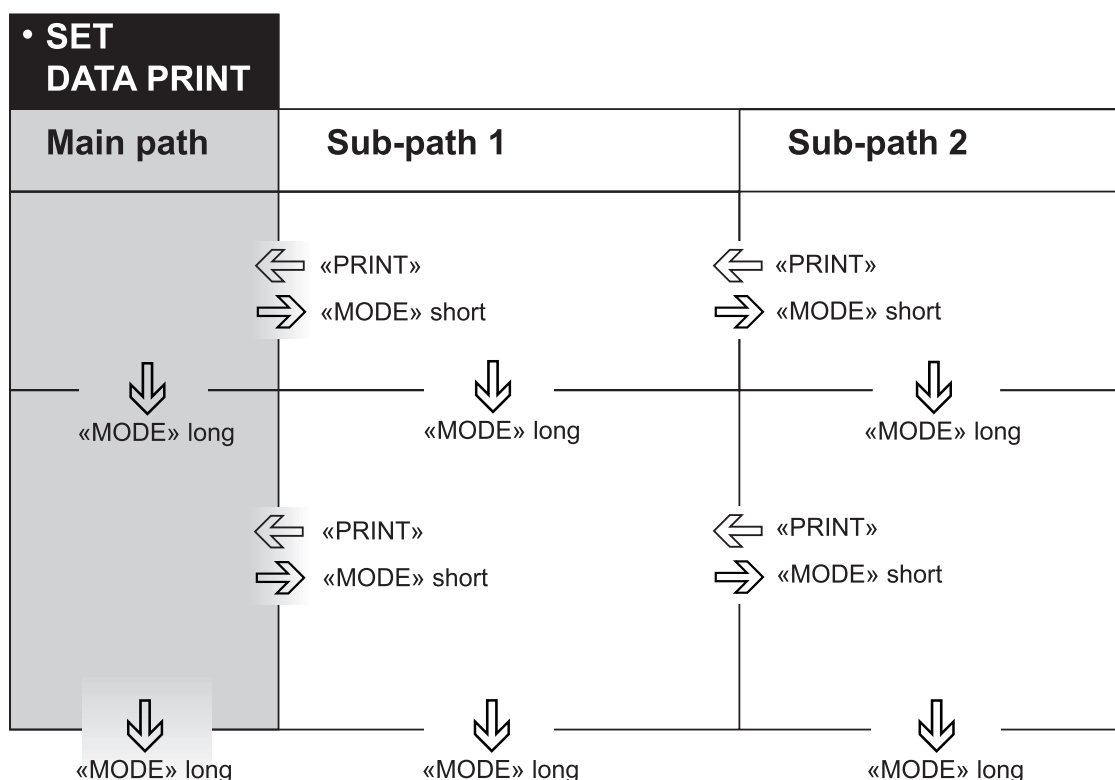

Input:

- **«MODE»**-short: Change value or position.
- **«MODE»**-long: Change one position to the right or terminate input.
- **«PRINT»**-button: Terminate input.





English

10.6.1 Operating in the weighing mode

	Name	Function during weighing
	«ON/OFF»	<ul style="list-style-type: none"> • Switching the balance on and off
	«MODE»	<ul style="list-style-type: none"> • Calling up the configuration menu and the application menu • Switches between the Basic program and the chosen application

■ 10 Modes of operation and operating

	Name	Function during weighing
	«O/T»	<ul style="list-style-type: none"> • Initiate Tare Function and/or Calibration Function
	«REF»	<ul style="list-style-type: none"> • Run application (see Chapter 12 “Working with the application menu”)
	«PRINT»	<ul style="list-style-type: none"> • Start print function • Exit the menu

! NOTE

For the operation of the «O/T» and «PRINT» see Chapter 13 “Special operating keys”.

For an illustration of the method of operation see Chapter 15 “Practical examples”.

10.6.2 Display

The balance display has two lines (1 and 2).

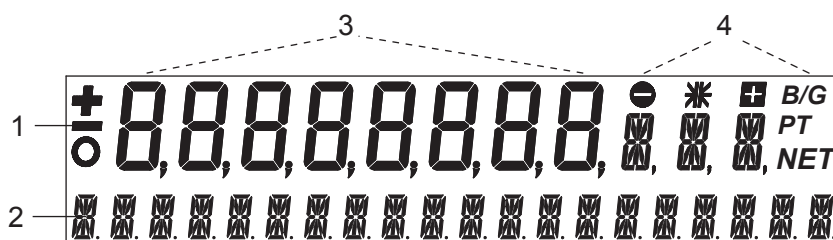

The upper display-line (1) includes the 8-figure measurement display (3) as well as various symbols (4).

The lower line (2) serves as a 20-character info-line in connection with the cursor keys for controlling the working programs.

10.7 Password protection of the menus

The two main menus of the balance can be protected by a freely selectable, four-figure password against unintentional changes.

- With password protection deactivated, any operator can change the balance configuration and application menus.
- With “medium” password protection activated, only the configuration menu is protected against unintentional changes.
- With “high” password protection activated, both the configuration menu and the application menu are protected against unintentional changes. Only after entering the correct, four-figure password can changes be made to the configuration menu and the application menu.

! NOTE

The password protection is deactivated at the works.

The **pre-programmed password** set in the works is: **7 9 1 4**

This password is the same for all balances and is always valid, in parallel with a self-selected password.

Make a note of your **personal password**.

10.8 Anti-theft encoding

The balance can be protected against theft by a freely selectable, four-figure numerical code:

- With anti-theft encoding deactivated, the balance can be switched on again and operated after interruption of the power supply without entering a code.
- With anti-theft encoding activated, the balance requires the entry of the four-figure code after each interruption to the power supply.
- If the code is input incorrectly, the balance is blocked.
- If the balance is blocked, it must first be turned off and turned on again and unblocked by entering the correct four-figure code.
- After eight consecutive incorrect entries the display will read "NO ACCESS, CALL SERVICE". In this case, only service can unblock the balance again.

 **NOTE**

The anti-theft-encoding is deactivated in the works.

The **pre-programmed code** set by the works is: **8 9 3 7**

This code is the same for all balances. For reasons of security you should therefore always select your own code.

Keep your personal code in a safe place.

To activate the anti-theft encoding and to alter the code programmed in the works to one which you have chosen yourself, see Chapter 11.10 "Anti-theft encoding".

11 Working with the configuration menu

This chapter describes the configuration menu and its functions.

To activate the menu, see Chapter 10.5 “Activating the two main menus” and Chapter 10.6 “How the menu control operates”.

11.1 Structure of the configuration menu

The basic adjustment of the balance is defined in the configuration menu:

Menu	Definable functions
LANGUAGE	Display language (E, G, F)
UNIT-1	Unit in which the weighing results are displayed
SET DATA PRINT	Print formats; Type of values to be printed (individual values, continuous printout, time or load change dependent values, date, time, user, etc.)
SET CALIBRATION	Calibration method
SET WEIGHING MODE	Stability mode (Quality of the balance location), Auto-Standby mode, zero correction, tare method (rapid or standard tare)
SET INTERFACE	Baud rate, parity, handshake functions of the peripheral interface
SET DATE AND TIME	Date and time (standard format or American format p.m. and a.m.)
PASSWORD	Password protection for defining the menus
THEFTCODE	Activating/deactivating and changing the anti-theft code
KEY TONE	Key tone
BUS	Enables disables Precisa BUS accessories

Printing conventions used in this document:

- The settings in the sub-paths pre-programmed in the works are printed in **bold** in these operating instructions.
- For greater clarity, only that part of the menu tree which corresponds to the function is shown with each description of the function.
- You will find the entire menu tree for the configuration menu in Chapter “«MODE»- and «O/T»- button pressed on switching on:”.
- Explanations of the menu functions are printed in *italics*.

11.2 Language-function

To activate the menu see Chapter 10.5 “Activating the two main menus” und Chapter 10.6 “How the menu control operates”.

• LANGUAGE		<i>Selecting a language</i>
LANGUAGE	ENGLISH	
SPRACHE	DEUTSCH	
LANGUE	FRANCAISE	

In order to alter the language, proceed as follows:

- Switch off balance.
- Switch on balance and depress «**MODE**» until the currently activated language is shown.
- Release «**MODE**».
- Press «**MODE**» repeatedly until the language you require is shown.
- Press «**PRINT**» in order to confirm the selection.
- Press «**PRINT**», in order to quit the menu.

11.3 Selecting the weight unit

To activate the menu see Chapter 10.5 “Activating the two main menus” and Chapter 10.6 “How the menu control operates”.

• UNIT-1		
UNIT-1	g	Gram
	kg	Kilogram
	-----	-----
	Bht	Baht

The balance can show results in different units, although with some balances display is not possible in milligrammes or kilogrammes because of the corresponding weight range.

Display	Weight unit	Conversion to grammes
g	Gram	
(mg)	Milligram	0.001 g
(kg)	Kilogram	1000 g
GN	Grain	0.06479891 g
dwt	Pennyweight	1.555174 g
ozt	Troy ounce	31.10347 g
oz	Ounce	28.34952 g
Lb	Pound	453.59237 g
ct	Carat	0.2 g
C.M.	Carat Metric	0.2 g
tLH	Tael Hong Kong	37.4290 g
tLM	Tael Malaysia	37.799366256 g
tLT	Tael Taiwan	37.5 g
mo	Momme	3.75 g
t	Tola	11.6638038 g
Bht	Baht	15.2 g

English

11.4 Print functions

To activate the menu see Chapter 10.5 “Activating the two main menus” and Chapter 10.6 “How the menu control operates”.

• SET DATA PRINT		
AUTO-START	ON/OFF	Start print automatically on switching on/off
MODE	UNSTABLE	Individual print, each value
	STABLE	Individual print, stable value
	LOADCHANGE	Print after load changes
	CONTINUOUS	Continuous print after every integration time
	TIMEBASE	Continuous print with time basis
TIMEBASE	2.0	Time basis (in seconds) freely selectable
SET PRINTFORMAT	DATE AND TIME	ON/OFF
	BALANCE-ID	ON/OFF
	PRODUCT-ID	ON/OFF
	GROSS AND TARE	ON/OFF
	UNITS	ON/OFF
	OPERATOR-ID	ON/OFF
	LINEFEED	OFF/1/2/..9/FROMFEED
PRODUCT	ttt...	

■ 11 Working with the configuration menu

	PRODUCTMODE	HOLD
		DELETE
		COUNT
	OPERATOR	ttt...

With "SET PRINTFORMAT", elements which are switched on are printed in each case:

- with "UNITS" all momentarily active units are printed out,
- with "LINEFEED" the specified numbers of lines are printed out or a formfeed is performed at the end of each printout,
- with "PRODUCT ttt..." the product name can be entered alphanumerically,
- with "PRODUCTMODE HOLD" this product name is stored,
- with "PRODUCTMODE DELETE" it is deleted after each printout,
- with "PRODUCTMODE COUNT" a counter, which is incremented by 1 after each printout,
- "OPERATOR ttt..." is the alphanumeric input of the operator.

When a peripheral device (for example a printer) is connected, the balance interface must be configured in the submenu "SET INTERFACE" (see Chapter 11.7 "Interface-functions").

11.5 Calibration functions

To activate the menu see Chapter 10.5 "Activating the two main menus" and Chapter 10.6 "How the menu control operates".

• SET CALIBRATION			
	MODE	OFF	<i>Closed</i>
		EXTERNAL	<i>External</i>
		EXT.-DEF.	<i>External with user-defined weight („DEF. n.nnn g")</i>
		INTERNAL	<i>with internal weight</i>
		AUTO	<i>Automatic (AUTOCAL)</i>
	DEF.	0.000 g	<i>Calibration weight for EXT.-DEF. mode</i>
	AUTOCAL.	TIME/TEMP.	<i>Auto-calibration on time and temperature</i>
	TEMPERATURE	<i>Auto-calibration on temperature</i>	
	TIME	<i>Auto-calibration on time</i>	
AUTOCAL.-TIME	6 h	<i>Time for auto-calibration</i>	
AUTO-WARNING	ON/OFF	<i>Shows a message if the balance recognizes a significant temperature change and therefore a calibration is recommended</i>	
REPORT	ON/OFF	<i>Printout calibration report</i>	

For the calibration of the balance see Chapter 9.7 "Calibration of the balance" and Chapter 16.1 "Calibration".

! NOTE

The works setting depends on the model of balance. The internal calibration modes are only available if the self calibration system (SCS) is installed.

11.6 Weighing mode

To activate the menu see Chapter 10.5 "Activating the two main menus" and Chapter 10.6 "How the menu control operates".

• SET WEIGHING MODE		
FLOATINGDISPLAY	0.08 0.16 0.32	<i>Input integration time (in seconds)</i>
STABILITY	LOW MEDIUM HIGH	<i>Setting the stability control (instability of the balance location)</i>
AUTO-STANDBY	OFF 0.5 MIN. 1 MIN. 5 MIN. 10 MIN.	<i>Auto-Standby not active or active after nn minutes</i>
AUTO-ZERO	ON/OFF	<i>Automatic zero correction on/off</i>
QUICK-TARE	ON/OFF	<i>Quick tare on/off</i>
ZERO-RANGE	0.000 g	<i>Maximum weight where a zero function is performed</i>

The value set for „FLOATINGDISPLAY“ defines the period after which each new measurement is displayed. For the definition of this period, the quality of the balance location is crucial. The stability control must also be set appropriately.

Recommended values:

- Optimum balance location: „FLOATINGDISPLAY 0.08“
- Good balance location: „FLOATINGDISPLAY 0.16“
- Critical balance location: „FLOATINGDISPLAY 0.32“

! NOTE
The value of the Floating Display is a function of the stability control and the balance location. For balance location, see chapter 9.4 "Choosing a suitable location" and see chapter 11.6 "Weighing mode".

English

The value set for the „STABILITY“ control depends on the quality of the balance location and must be correctly chosen in order to obtain optimum, reproducible results. Choose:

- Optimum balance location: „STABILITY LOW“
- Good balance location: „STABILITY MEDIUM“
- Critical balance location: „STABILITY HIGH“

With the aid of the „AUTO-STANDBY“ function, you can define the period of non-use before the balance automatically switches into the energy-saving mode.

The Auto-Standby mode turns off the balance automatically, if:

- the balance is tared and has shown “Zero” for at least nn minutes
- the balance has received no remote control command via the interface for at least nn minutes,
- the automatic zero correction „AUTO-ZERO“ is activated.

It is possible to re-start the balance after it has been switched off by an automatic Auto-Standby:

- Briefly press any key
- Put a weight on the balance
- Make a remote control command via the interface

! NOTE
The Auto-Standby function only works with the automatic zero-correction activated („AUTO-ZERO“).

If the automatic zero correction „AUTO-ZERO“ is activated, the balance always gives a stable zero (e.g. even with fluctuations in room temperature).

The „QUICK-TARE“ forces the balance to perform a tare immediately when pressing «0/T» or sending the remote command to tare, independent of the stability of the balance.

The „ZERO-RANGE“ defines the maximum weight where the balance will perform a zero function instead

■ 11 Working with the configuration menu

of a normal tare when pressing «0/T» or sending the remote command to tare. This value can be adjusted to make sure a small load is really saved in the tare and therefore printout e.g. on a report as tare value.

11.7 Interface-functions

To activate the menu see Chapter 10.5 “Activating the two main menus” and Chapter 10.6 “How the menu control operates”.

• SET INTERFACE		
BAUDRATE	300 600 1200 2400 4800 9600 19200 38400 57600	Select baud rate
PARITY	7-EVEN-1STOP 7-ODD-1STOP 7-NO-2STOP 8-NO-1STOP 8-EVEN-1STOP 8-ODD-1STOP	Select parity
HANDSHAKE	NO XON-XOFF HARDWARE	Select handshake function
PC DIRECT MODE	ON/OFF	Set PC direct mode
CHARACTER SET	ENG GER FRA	Select the character set for the PC direct mode according to the keyboard which is used on the PC
FORMAT	LINES TABLE	Select line or table data format for the PC direct mode according to your application on the PC

With the aid of the interface functions, the RS232/V24 interface of the balance is matched to the interface of a peripheral device (see Chapter 14 “Data transfer”).

The „PC DIRECT MODE“ enables/disables a direct communication with Windows PC’s, enabled in the integrated support for handicapped as an external input device. Set the interface to 9600, 8-NONE-1STOP, NO.

11.8 Date and time

To activate the menu see Chapter 10.5 “Activating the two main menus” and Chapter 10.6 “How the menu control operates”.

• SET DATE AND TIME		
DATE	[DD.MM.YY]	Set date and time
TIME	[HH.MM.SS]	
FORMAT	STANDARD/US	

NOTE

The date and time display continues in the event of a power failure. If this is not the case, the balance backup battery is exhausted and must be replaced by the customer service.

11.9 Password protection

To activate the menu see Chapter 10.5 “Activating the two main menus” and Chapter 10.6 “How the menu control operates”.

• PASSWORD			
PASSWORD - - - -	DATA-PROTECTION	OFF	<i>No protection</i>
	DATA-PROTECTION	MED	<i>The configuration menu is protected</i>
	DATA-PROTECTION	HIGH	<i>The configuration menu and the application menu are protected</i>
	NEW PASSWORD	----	<i>Enter new password</i>

The password protection permits you to protect the application menu and/or the configuration menu against unintentional changes.

See Chapter 10.7 “Password protection of the menus” and Chapter 15.1.4 “Activation of password protection” for further information on password protection.

11.10 Anti-theft encoding

To activate the menu see Chapter 10.5 “Activating the two main menus” and Chapter 10.6 “How the menu control operates”.

• THEFTCODE			
THEFTCODE ----	THEFT-PROTECTION	ON/OFF	<i>Switch encoding on/off</i>
	NEW CODE	----	<i>Enter a new code</i>

If the anti-theft encoding is activated, a four-figure code must be entered after every interruption of the power supply in order to release the balance for use.

For further information on the anti-theft encoding see Chapter 10.8 “Anti-theft encoding”.

To activate the anti-theft encoding, proceed as described for password protection.

11.11 Keyboard settings

To activate the menu see Chapter 10.5 “Activating the two main menus” and Chapter 10.6 “How the menu control operates”.

• KEY TONE	
KEY TONE	ON/OFF <i>Switch key tone on and off</i>

If the „KEY TONE“ is switched on, a short audio signal sounds each time a key is pressed.

11.12 Precisa BUS

To activate the menu see Chapter 10.5 “Activating the two main menus” and Chapter 10.6 “How the menu control operates”.

• BUS	
BUS	ON/OFF <i>Enables the Precisa BUS functionality, mandatory if Precisa BUS accessories are connected</i>

12 Working with the application menu

This chapter explains which working programs the balance has and how these are operated (see also Chapter 10.5 “Activating the two main menus” and Chapter 10.6 “How the menu control operates”). If «PRINT» is operated in an application, a report corresponding to the application is printed out.

12.1 Structure of the application menu

To activate the menu see Chapter 10.5 “Activating the two main menus” and Chapter 10.6 “How the menu control operates”.

The working programs of the balance are called up using the application menu and adapted to the user's needs:

Menu	Definable functions
SET APP.	Select application program
SETUP APPLICATION	Specify parameters for the application program selected
AUTO-START ON/OFF	The selected application program can, if required, be loaded automatically every time the balance is switched on

Printing conventions:

- The settings for the sub-menus programmed in works are printed in **bold** in these operating instructions
- For a greater clarity, only that part of the menu tree which corresponds to this application is shown with each application description.
- You will find the complete menu tree for the application menu in Chapter 17.2 “Application menu tree”.
- Explanations of the menu functions are printed in *italics*.

12.2 Selecting a working program

See Chapter 10.5 “Activating the two main menus” and Chapter 10.6 “How the menu control operates” for the activation of the application menu.

• SELECT APPLICATION		
SET APP.	OFF	<i>Normal weighing</i>
	UNITS	<i>Different weight units</i>
	COUNT	<i>Piece counting</i>
	PERCENT	<i>Percent weighing</i>
	NET-TOTAL	<i>Add weighing results with intermediate tare</i>
	ANIMAL	<i>Animal weighing</i>
	DENSITY	<i>Density determination</i>
	DIAGNOSTICS	<i>Diagnostics functions</i>

In this function-field, select the desired working program.

If a working-program is selected in the “SET APP.” menu, then only those sub-menus, which contain functions and parameters necessary to define the chosen working program are shown in the “SETUP APPLICATION” menu.

To activate the menu see Chapter 10.5 “Activating the two main menus” and Chapter 10.6 “How the menu control operates”.

12.3 Changing application / weighing mode

To activate an application, it must first be selected in the application menu (see Chapter 12.2 "Selecting a working program").

- Press the «**MODE**» button. The display will show either the name of the selected application "UNITS", "COUNT", ... or "WEIGHING" (for switching back to weighing mode).
(If "SET. APP. OFF" appears immediately, no application has yet been selected.)
- Release the «**MODE**» button.
- The balance has now switched over to the application and you can run the application with the «**REF**» button. NOTE, in the weighing mode the «**REF**» button has no function.

12.4 Application "UNITS"

See Chapter 10.5 "Activating the two main menus" and Chapter 10.6 "How the menu control operates" for the activation of the application menu.

• SETUP APPLICATION			
UNITS	UNIT-2	mg	Milligram
	----	----	----
		OFF	not active
	UNIT-3	GN	Grain
	----	----	----
		OFF	not active
UNIT-4	ct	Carat	
----	----	----	
	OFF	not active	

! NOTE

For basic operation, Unit 1 is defined in the configuration menu (standard unit for all weighings, if the working-program "UNITS" is not called up, see Chapter 11.3 "Selecting the weight unit").

Operation:

Start the application (see Chapter 12.3 "Changing application / weighing mode").

- Press the «**REF**» button until the desired unit appears on the display.
- Release the «**REF**» button.

12.5 Application "COUNT"

See Chapter 10.5 "Activating the two main menus" and Chapter 10.6 "How the menu control operates" for the activation of the application menu.

• SETUP APPLICATION		
COUNT	REFERENCE	5 PCS
		Reference-number of pieces = 10

With the aid of the "COUNT" program you can count items of uniform weight (screws, balls, coins, etc.).

! NOTE

Depending on the weight and tolerances of the objects to be counted, you should count a representative number of items for the regulation of the reference-weight.

Operation:

Start the application (see Chapter 12.3 "Changing application / weighing mode").

- Place a number of objects on the weighing pan.
- Press the «**REF**»-button until the reference quantity appears on the display.

■ 12 Working with the application menu

- If the reference quantity is correct release the «REF»-button.
Otherwise hold down the «REF»-button. The pre-defined values will appear (1, 10, 25, 50, ...). As soon as the desired value appears release the «REF»-button. (The current value can be increased by 1 by briefly releasing and pressing the «REF»-button.)

12.6 Application “PERCENT”

See Chapter 10.5 “Activating the two main menus” and Chapter 10.6 “How the menu control operates” for the activation of the application menu.

• SETUP APPLICATION	
PERCENT	DECIMALS AUTO <i>Enter number of decimal places.</i>
	0 <i>The number of places that can be selected</i>
	1 <i>after the decimal point depends on the</i>
	2 <i>balance model.</i>
	etc.

With the aid of the “PERCENT” program you can display and print out the weight of different measurements as a percentage of a previously defined reference weight.

Operation:

Start the application (see Chapter 12.3 “Changing application / weighing mode”).

- Place the reference weight on the weighing pan.
- Press the «REF»-button until “REFERENCE 100%” appears on the display.
- Release the «REF»-button.

12.7 Application “NET-TOTAL”

There is no Setup menu for this application.

With the aid of the „NET-TOTAL“ application you can add individual weighings, where the balance is tared to zero again before each individual weighing.

Functions of the application:

- «STO n»: - Take stable value and add to the sum of the components.
 - Tare balance.
 - Short acoustic confirmation
- «WAIT i»: Value not stabilized yet
- «RES»: - Reset
- «INF»: - Display of:
 - Total weight
 - Residual capacity
 - Individual components
 - Exit info with «MODE»-button.

Note:

By pressing the «MODE»-button you can switch to display the total load, e.g. to fill-up to a specific weight. Press the «MODE»-button again to go back to the „NET-TOTAL“ application and its display.

Operation:

Start the application (see Chapter 12.3 “Changing application / weighing mode”).

- Place something on the weighing pan.
- Press the «REF»-button until the desired function flashes on the display.
- Release the «REF»-button.

12.8 Application “ANIMAL”

See Chapter 10.5 “Activating the two main menus” and Chapter 10.6 “How the menu control operates” for the activation of the Application menu.

• SETUP APPLICATION		
ANIMAL	MEASURETIME	4 <i>Enter time in seconds</i>

With the aid of the „ANIMAL” program you can weigh living animals accurately, even if they move on the scale-pan.

The balance measures continuously throughout the period defined by the user in the Setup menu, averages the stored values at the end of the measuring period and displays average-measurement thus obtained.

Functions of the application:

- «MANUAL»: - Manual release of the measurement.
- «AUTO»: - Start automatic release of the measurement with a second delay after each load-change.
- «STOP»: - Stop automatic measurement.

Operation:

Start the application (see Chapter 12.3 “Changing application / weighing mode”).

- Place the animal on the weighing pan.
- Press the «REF»-button until the desired function flashes on the display.
- Release the «REF»-button.

12.9 Application “DENSITY”

See Chapter 10.5 “Activating the two main menus” and Chapter 10.6 “How the menu control operates” for the activation of the Application menu.

• SETUP APPLICATION			
DENSITY	MODE	SOLID ON BOTTOM	<i>Solid body</i>
	MODE	SOLID IN AIR	<i>Solid (under-floor)</i>
	MODE	LIQUID	<i>Measure liquids</i>
	MODE	SOLID POROUS	<i>Solid porous bodies</i>
	INDEX	ON/OFF	<i>Index on/off</i>
	REFERENCE	8.000	<i>Reference for index</i>
	TIMEBASE	0.0	<i>Time base for repeat in seconds</i>
	REF. DENSITY	0.998205	<i>Density of the liquid used for the measurement (set at works for water at 20°C)</i>
	TEMPERATUR	20.0 C	<i>Temperature of the water used for the measurement</i>
	DECIMALS	3	<i>Decimal places for density calculation</i>

You can carry out density determinations with the aid of the “DENSITY” program. For this, different modes of density determinations can be selected.

! NOTE

A Density Measurement Set (see Chapter 6 “Accessories”) is available as an optional extra. But you can also determine the density of solids without this accessory.

• Functions of the application on initialization:

- «OK»: - Accept current reference density
- «CAL»: - Calculate reference density of the measuring liquid
- «T-H2o»: - Set reference density to water at nn.n °C
- «20.0C»: - Set reference density to water at nn.n °C

■ 12 Working with the application menu

• Functions of the application on measurement:

- «AIR», etc - Invitation to measure the corresponding value
- «<->»: -“Switch” from index to density
- «SET»: - Executes corresponding step
- «STO»: - Stores corresponding value (statistics)

Operation:

Start the application (see Chapter 12.3 “Changing application / weighing mode”).

- Press the «REF»-button until the desired function flashes on the display.
- Release the «REF»-button.

The program leads the operator through the individual operating steps.

12.9.1 Density determination “Solid on bottom mode”

A temperature-controlled reference-liquid (water) is poured into a bowl, placed on the scale pan and tared. The solid is then placed into the liquid and weighed. Subsequently, the solid is suspended so that it is still completely immersed in the water, but no longer touches the base. It is weighed again.

From the weights, the balance determines the density of the solid.

12.9.2 Density determination “Solid in air mode”

With this weighing method, the solid is weighed with the aid of under-floor weighing (see Chapter 5 “Below-balance weighing”).

The solid is then placed in the temperature-controlled reference liquid (water) so that it does not touch the base of the bowl, but is nevertheless fully immersed in the water. Weighing is again carried out.

From the weights, the balance determines the density of the solid.

12.9.3 Density determination “Liquid mode”

The density of a liquid is determined using this method of weighing.

The procedure is exactly the same as with the density determination by the “Solid in air” method. A glass object with a volume of 10 cm³ or 100 cm³ is used as the solid (available as accessories, see Chapter 6 “Accessories”).

12.9.4 Density determination “Solid porous mode”

The density of a porous solid is determined with this method of weighing.

In order to carry out such measurements, you will require the Density Determination Kit (see Chapter 6 “Accessories”). The instruction manual supplied with this kit describes the procedure for the density-measurement.

12.10 Application “DIAGNOSTICS”

See Chapter 10.5 “Activating the two main menus” and Chapter 10.6 “How the menu control operates” for the activation of the application menu.

There is no Setup menu for this application.

Functions of the application:

- «REPEATABILITY TEST»: - Start the Automatic Repeatability Test, where the internal weight is measured 10 times, and the standard deviation is calculated from this and logged.

Operation:

Start the application (see Chapter 12.3 “Changing application / weighing mode”).

- Press the «REF»-button until the desired function flashes on the display.
- Release the «REF»-button.

Operation of the Automatic Repeatability Test:

Display	Step
<pre> +0,0000 9 REPEATABILITY TEST </pre>	Press «REF» until „REPEATABILITY TEST“ appears, then release the key.
<pre> -- 0000 MEASUREMENT 1 EXIT </pre>	The balance carries out a Zero measurement (-- 0.000 g is shown flashing).
<pre> -- INT MEASUREMENT 1 EXIT </pre>	The internal weight, if available, is applied and measured (-- Int is shown flashing).
<pre> -- LLLL MEASUREMENT 1 EXIT </pre>	In case no internal weight (SCS) is available place a load onto the balance (-- LLLL is shown flashing).
<pre> -- 0000 MEASUREMENT 2 EXIT </pre>	The balance carries out a Zero measurement again.
<pre> -- INT / LLLL MEASUREMENT 1 EXIT </pre>	The internal weight is applied and measured again or place the same external weight again.
	The balance repeats this measurements for 10 cycles.
<pre> +0,00008 9 STANDARD-DEV. EXIT </pre>	The standard deviation of the measurement is calculated and displayed and a report is printed.
	Press «REF» to exit the repeatability test at anytime.

13 Special operating keys

13.1 The Tare key «O/T»

- **Effects taring**
 - Ensure that the balance is in the weighing mode
 - Briefly press «O/T»
 - The balance performs a tare operation.
- **Effects a calibration**
 - Ensure that the balance is in the weighing mode
 - Keep «O/T» pressed until “CALIBRATION” is displayed
 - Release «O/T»
 - The balance carries out a calibration in accordance with the settings in the configuration menu (cf. Chapter 11.5 “Calibration functions”) and reports these by means of a printout.

NOTE

A calibration can be cancelled with «ON/OFF».

13.2 The Print key «PRINT»

- **Print out an individual value or a report**
 - Ensure that the balance is in the weighing mode
 - Briefly press «PRINT»
 - The individual value or report will be printed out.
- **Reset product counter to 1**
 - Ensure that the balance is in the weighing mode
 - Keep «PRINT» pressed until “RESET PROD.-COUNTER” is displayed
 - Release «PRINT»
 - The product counter will be reset to 1.
- **Print out a balance status**
 - Ensure that the balance is in the weighing mode
 - Keep «PRINT» pressed until “PRINT STATUS” is displayed
 - Release «PRINT»
 - The balance status will be printed out.
- **Print out the application-setup**
 - Ensure that the balance is in the weighing mode
 - Keep «PRINT» pressed until “PRINT APPLICATIONS” is displayed
 - Release «PRINT»
 - The application-setup will be printed out.
- **Print out the calibrations information**
 - Ensure that the balance is in the weighing mode
 - Keep «PRINT» pressed until “PRINT CALIBRATIONS” is displayed
 - Release «PRINT»
 - Information on the last 50 calibrations is printed. The time and date, as well as the temperature in the balance at the time of calibration in degrees Celsius. If more than 50 calibrations have been performed, the oldest are deleted.
- **Print out the firmware update history**
 - Ensure that the balance is in the weighing mode
 - Keep «PRINT» pressed until “PRINT FIRMWARE HIST” is displayed
 - Release «PRINT»
 - Information on the firmware which has been loaded together with the time and date is printed.

14 Data transfer

For data-transfers to peripheral devices, the balance is equipped with an RS232/V24-interface.

Before the data-transfer, the RS232 interface must be matched with the one in the peripheral device in the balance configuration menu (see chapter 11.7 "Interface-functions").

- **Handshake**

The handshake is set to „NO“ (none) at the factory. It can be set to software handshake „XON-XOFF“, or to hardware handshake „HARDWARE“.

- **Baud rate**

Possible baud rates: 300, 600, 1200, 2400, 4800, 9600, 19200, 38400, 57600 baud.

- **Parity**

Possible parity: 7 even 1 stop, 7 odd 1 stop, 7 no 2 stop, 8 no 1 stop, 8 even 1 stop, 8 odd 1 stop.

Pos.	0	1	2	3	4	5	6	7	8	9	10
7-even-1	SB	1.DA	2.DA	3.DA	4.DA	5.DA	6.DA	7.DA	PB	SP	-
7-odd-1	SB	1.DA	2.DA	3.DA	4.DA	5.DA	6.DA	7.DA	PB	SP	-
7-no-2	SB	1.DA	2.DA	3.DA	4.DA	5.DA	6.DA	7.DA	1.SP	2.SP	-
8-no-1	SB	1.DA	2.DA	3.DA	4.DA	5.DA	6.DA	7.DA	8.DA	SP	-
8-even-1	SB	1.DA	2.DA	3.DA	4.DA	5.DA	6.DA	7.DA	8.DA	PB	SP
8-odd-1	SB	1.DA	2.DA	3.DA	4.DA	5.DA	6.DA	7.DA	8.DA	PB	SP

SB: Start bit PB: Parity bit
DA: Data bit SP: Stop bit

- **Display**

S D7 D6 D5 D4 D3 D2 D1 D0 U U U

The data-transfer takes place in ASCII code:

1	2	3	4	5	6	7	8	9	10	11	12	13	14	15
B	B	B	S	D7	D6	D5	D4	D3	D2	D1	DP	D0	B	U	...	CR	LF

B Blank (space)
S Sign (+, -, space)
DP Decimal point
D0...D7 Digits
U ... Unit (only if the weight is stable, otherwise no unit is sent)
CR Carriage return
LF Line feed

! NOTE

Unused positions are filled with spaces. The decimal point DP can be between D0 and D7.
If the value format is user defined, the format is not as mentioned above!

14.1 Connection scheme

- **Standard, duplex connection including lines for optional hardware handshake with the peripheral device**

Balance	DB 9 female	D25 / D9	Peripheral device
RS 232 out	2 →	3 / 2	RS 232 in
RS 232 in	3 ←	2 / 3	RS 232 out
GND	5 —	7 / 5	GND
CTS	4 ←	20 / 4	DTR (only needed for hardware handshake)
DTR	8 →	5 / 8	CTS (only needed for hardware handshake)

14.2 Remote control-commands

Command	Function
ACKn	Acknowledge n=0 off; n = 1 on
CAL	Start calibration
D.....	Describe weight display (right-aligned)
DN	Reset weight display
@.....	Describe Info display
@N	Reset Info display
In	Set FLOATINGDISPLAY time n n=0 t = 0.08 s n = 1 t = 0.16 s n = 2 t = 0.32 s
N	Reset balance
OFF	Switch off balance
ON	Switch on balance
PCxxxx	Enter anti-theft code
PDT	Print out date and time
PRT	Print function, like pressing the «PRINT» key
PST	Print status report
Pn (ttt.t)	Set print mode: n = 0 individually print each value (unstable) n = 1 Individually print each value (stable) n = 2 Print after change of load n = 3 Print after each integration period n = 4 Print on time basis in s (ttt.t)
R%k	Set current weight = 100% with k=0...7 decimal places (k=A: use automatic positioning of decimal point)
REF%k rrr	Set reference weight rrr for 100% with k=0...7 decimal places (k=A: use automatic positioning of decimal point)
Rnnn	Set current weight = nnn items
REFrrr	Set reference weight rrr for 1 item
Sn	Set stability n n = 0 low n = 1 medium n = 2 high
SDTttmmjjhhmmss	Set date and time (German) (Tag, Monat, Jahr, Stunde, Minute, Sekunde)
SDTmddyyhhmmss	Set date and time (English) (Month, Day, Year, Hour, Minutes, Seconds)
T (ttt)	Tare or set tare to a specific value
Uxnn	Set unit x (1...4) of the balance with nn (0 = g, 1 = mg, 2 = kg, ...)
UxS	Switch balance to unit x (1...4)
ZERO	Zero balance (provided weight is stable and within the zero position range)

! NOTE

Each remote control-command must terminate with «CR» «LF». The commands are acknowledged if required.

14.2.1 Examples for the remote control

Input	Description of the function executed
D - - - - -	Five dashes are displayed
DTEST123	tEST123 is displayed
D	The display is dark
T100	-100.000 g (Tare set to 100 g)
T1	-1.000 g (Tare set to 1g)
T	Balance is tared

15 Practical examples

15.1 Changing the configuration menu

See Chapter 10.5.1 “Activating the configuration menu”, for the activation of the configuration menu.

15.1.1 Setting the choice of language

In order to alter the display language, proceed as follows:

- | | |
|------------------|---|
| SPRACHE DEUTSCH | <ul style="list-style-type: none"> • Press «MODE» and hold down until the currently set language appears. • Release the «MODE»-button. |
| or | |
| LANGUE FRANCAISE | <ul style="list-style-type: none"> • Press «MODE» repeatedly, until the desired language is displayed (the display will flash). • Hold down «MODE» until entry is complete (display ceases to flash) or press «PRINT». • Press «PRINT» to exit menu. |
| or | |
| LANGUAGE ENGLISH | |
| LANGUAGE ENGLISH | |

15.1.2 Setting the Weight unit

In order to alter the weight unit, proceed as follows:

- | | |
|-----------|--|
| UNIT-1 g | <ul style="list-style-type: none"> • Press «MODE» and hold down until the currently set unit appears. • Release the «MODE»-button. |
| UNIT-1 OZ | |
| UNIT-1 OZ | <ul style="list-style-type: none"> • Press «MODE» repeatedly, until the desired unit is displayed (the display will flash). • Press «PRINT» to confirm the input (display ceases to flash). • Press «PRINT» again to exit menu. |

15.1.3 Setting the Print functions

In order to alter the print parameters proceed as follows:

- | | |
|----------------|---|
| SET DATA PRINT | <ul style="list-style-type: none"> • Press «MODE» and hold down until “SET DATA PRINT” appears. • Release the «MODE»-button. |
| AUTO-START OFF | |
| AUTO-START ON | <ul style="list-style-type: none"> • Press «MODE» briefly. “AUTO-START ...” will appear. |
| MODE STABLE | <ul style="list-style-type: none"> • Press «MODE» repeatedly, until the desired setting is displayed (ON or OFF will flash). |
| MODE TIMEBASE | <ul style="list-style-type: none"> • Press «MODE» and hold down the button until the next print function appears (“MODE ...”). • Release the «MODE»-button. • Press «MODE» repeatedly, until the desired setting is displayed. |
- Press «MODE» again and hold down the button until the next print function appears. Change the setting in the same way.
 - Press «PRINT» to return to “SET DATA PRINT”.
 - Press «PRINT» again to exit menu.

■ 15 Practical examples

15.1.4 Activation of password protection

The possibilities for setting the password protection are described in Chapter 11.9 "Password protection". In order to activate password protection, proceed as follows:

- | | |
|---------------------|--|
| PASSWORD ---- | <ul style="list-style-type: none">• Press «MODE» and hold down button until "PASSWORD ----" appears.• Release the «MODE»-button. |
| PASSWORD 1000 | <ul style="list-style-type: none">• Press «MODE» briefly. The first digit of the password will flash.• Enter the first digit by briefly pressing «MODE» repeatedly. |
| PASSWORD 7100 | <ul style="list-style-type: none">• Press «MODE» until the second digit flashes. Enter the second digit by briefly pressing «MODE» repeatedly. |
| PASSWORD 7914 | <ul style="list-style-type: none">• In the same way enter the third and fourth digit of the password.• Hold down «MODE» until input is complete (no digit flashing). |
| DATA-PROTECTION OFF | <ul style="list-style-type: none">• Press «MODE» briefly. "DATA-PROTECTION ..." will appear.• Press «MODE» repeatedly, until the desired data-protection is displayed (the setting will flash). |
| NEW PASSWORD 7914 | <ul style="list-style-type: none">• Press «MODE» and hold down button until "NEW PASSWORD 7914" appears.• Release the «MODE»-button. |
| NEW PASSWORD 1234 | <ul style="list-style-type: none">• Your own new password can now be entered in a similar manner to the foregoing. |
| PASSWORD ---- | <ul style="list-style-type: none">• Press «PRINT» to return to "PASSWORD ----".• Press «PRINT» to exit menu. |

15.2 Selection of an application program

See Chapter 10.5.2 "Activating the application menu" for the activation of the application menu.

15.2.1 Setting for Counting by weighing

For Setup, see Chapter 12.5 "Application "COUNT""

To count uniformly heavy objects such as coins, screws or similar things, proceed as follows:

- | | |
|-------------------|--|
| SET APP. ... | <ul style="list-style-type: none">• Press «MODE» and hold down button until the currently set application appears.• Release the «MODE»-button. |
| SET APP. COUNT | <ul style="list-style-type: none">• Press «MODE» repeatedly, until "SET APP. COUNT" is displayed (the application will flash).• Press «PRINT» to confirm the input. |
| SETUP APPLICATION | <ul style="list-style-type: none">• Press «MODE» until "SETUP APPLICATION" appears.• Release the «MODE»-button. |
| REFERENCE 10 PCS | <ul style="list-style-type: none">• Press «MODE» briefly, the currently set reference quantity appears.• Release the «MODE»-button. |
| REFERENCE 010 PCS | <ul style="list-style-type: none">• Press «MODE» briefly. The first digit of the reference quantity will start to flash.• Enter the first digit by briefly pressing «MODE» repeatedly. |
| REFERENCE 020 PCS | <ul style="list-style-type: none">• Press «MODE» until the second digit flashes. Enter the second digit by briefly pressing «MODE» repeatedly. |
| REFERENCE 025 PCS | <ul style="list-style-type: none">• In the same way enter the third digit of the reference quantity.• Hold down «MODE» until input is complete (no digit flashing).• Press «PRINT» twice to exit menu. |

By briefly depressing the «**MODE**»-button you can change to "COUNT".

Place the set number of objects on the weighing pan. The reference weight for the count will be defined by briefly depressing the «**REF**»-button.

16 Maintenance and servicing

16.1 Calibration

The calibration of the balance is fixed in the configuration menu (see Chapter 9.7 "Calibration of the balance" and Chapter 11.5 "Calibration functions").

Possible types of calibration, depending on the model of balance:

- External calibration by means of ICM (Intelligent Calibration Mode)
- External calibration with freely selectable weight
- Internal calibration
- Automatic calibration

! NOTE

The calibration can be interrupted at any time by pressing «ON/OFF».

16.1.1 External calibration by means of ICM

Depending on the type of balance, calibration weights in steps of 10 g, 50 g, 100 g and 500 g can be used, where the calibration weight must correspond to the precision of the balance.

For an external calibration by means of ICM, "SET CALIBRATION MODE EXTERNAL" must be selected in the configuration menu (see Chapter 11.5 "Calibration functions").

- | | |
|-------------|--|
| CALIBRATION | <ul style="list-style-type: none"> • Switch to "WEIGHING" with the «MODE»-key • Press «0/T» until "CALIBRATION" appears. |
| -- 0000 g | <ul style="list-style-type: none"> • The balance carries out a Zero measurement (0.000 g is shown flashing) |
| -- 2000 g | <ul style="list-style-type: none"> • After the zero measurement the display flashes with the recommended calibration weight • Place the calibration weight on the pan • The display flashes first rapidly than slowly |
| -- 2000 g | <ul style="list-style-type: none"> • The display flashes first rapidly than slowly |
| + 2000 g | <ul style="list-style-type: none"> • Calibration is complete when the display stops flashing |

16.1.2 External calibration with freely selectable weight

For an external calibration with user-definable weight, "SET CALIBRATION MODE EXT. -DEF." must be selected in the configuration menu (see Chapter 11.5 "Calibration functions").

Then, the effective value of the calibration weight (DEF. n'nnn g) must be entered with up to tenfold precision compared with the balance.

! NOTE

If calibration is carried out with the free weight, then only this weight may be used.

Then proceed as follows:

- | | |
|-------------|--|
| CALIBRATION | <ul style="list-style-type: none"> • Switch to "WEIGHING" with the «MODE»-key • Press «0/T» until "CALIBRATION" appears. |
| -- 0000 g | <ul style="list-style-type: none"> • The balance carries out a Zero measurement (0000 g is shown flashing) |

■ 16 Maintenance and servicing

-- 372 g

- After the zero measurement the display flashes with the previously entered calibration weight
- Place the calibration weight on the pan
- The display flashes first rapidly than slowly

-- 372 g

+ 372,15 g

- Calibration is complete when the display stops flashing (the exact weight is shown)

16.1.3 Internal calibration

For an internal calibration with the built-in calibration weight "SET CALIBRATION MODE INTERNAL" must be selected in the configuration menu (see Chapter 11.5 "Calibration functions").

Then proceed as follows:

- Switch to "WEIGHING" with the «MODE»-key
- Press «0/T» until "CALIBRATION" is shown.
- The calibration is finished after a certain period of time.

16.1.4 Automatic calibration

For an automatic calibration with the built-in calibration weight "SET CALIBRATION MODE AUTO" must be selected in the configuration menu (see Chapter 11.5 "Calibration functions").

The balance now calibrates itself automatically every 24 hours and/or after each temperature change of 3 degrees Celsius, depending on the definition in the configuration menu "SET CALIBRATION AUTOCAL". The time of the automatic calibration is as determined in the configuration menu under "SET CALIBRATION AUTOCAL. -TIME n h" (e.g. 6 h for 06.00 o'clock in the morning).

! NOTE

For the automatic calibration by time and by time/temp. the date and time of the balance must first be correctly set (see Chapter 11.8 "Date and time").

The calibration can also be effected manually any time while auto-calibration is activated.

The automatic calibration then takes place only if no weight is placed on the pan for at least five minutes.

It is recommended, that the time for the auto-calibration be set at a time outside the normal business hours (for example, in the early morning).

16.2 Firmware update

Our balances are instruments which are being continuously advanced and improved. For this reason, it is possible to update to the latest version of the instrument firmware from the internet.

In order to update your firmware, you need to download the Universal Download Tool from the website and install it onto a PC with Windows.

The firmware for the balance can also be downloaded from the Downloads area on the website. This can then be loaded into the instrument with the aid of the Universal Download Tool.

16.3 Cleaning

The balance must be treated carefully and cleaned regularly. It is a precision instrument.

! DANGER

For maintenance work, the balance must be separated from the power supply (remove power adaptor plug from socket). Also ensure that the balance cannot be reconnected to the power supply during the work by a third party.

Take care during cleaning that no liquid penetrates into the balance. If liquid is spilt on the balance, the latter must immediately be disconnected from the electricity supply and must only be used again after it has first been checked by a Service Engineer.

The connections of the balance and the power adaptor must not come into contact with liquids.

Regularly dismantle the weighing pan and the weighing pan holder and remove any dirt or dust from under the weighing pan and on the balance housing with a soft brush or a soft, lint-free cloth, moistened with a mild soap solution.

The weighing pan and the holder can be cleaned under running water. Take care that both parts are completely dry before they are re-installed on the balance.



WARNING

Never use solvents, acids, alkalis, paint thinners, scouring powders or other aggressive or corrosive chemicals for cleaning, since these substances attack the surfaces of the balance housing and can cause damage.

The regular maintenance of the balance by your Service Representative will guarantee unlimited function and reliability over many years and will extend the lifespan of the balance.

16.4 Error messages

The balance shows a description of the fault in the info-line.



NOTE

If an error occurs without a description of the error in the info-line, the Customer Service must be called.

16.4.1 Notes on correcting faults

The following table shows faults and their possible causes. If you cannot clear the fault using the table, please contact the Customer Service..

Fault	Possible cause
Weight display does not light	<ul style="list-style-type: none"> • Balance not switched on • Connection to power adaptor is interrupted • Power supply has failed (interruption to current) • The power adaptor is defective
“OL” is shown in display	<ul style="list-style-type: none"> • The weight range has been exceeded (Observe information on the maximum weight range)
“UL” is shown in display	<ul style="list-style-type: none"> • The weight range is below the range of the balance (Scale pan or scale pan holder missing)
The weight display fluctuates continuously	<ul style="list-style-type: none"> • The draft is too strong at the balance location • The balance support is vibrating or varying • The scale pan is touching a foreign body • The time chosen for FLOATINGDISPLAY is too short • The material being weighed is absorbing moisture • The material being weighed is being blown away or is evaporating • Strong temperature variations in the material being weighed
Results of weighing are clearly incorrect	<ul style="list-style-type: none"> • The balance was not correctly tared • The balance is not correctly levelled • The calibration is no longer correct • There are strong temperature variations
There is no display or only dashes	<ul style="list-style-type: none"> • The stability control (Balance functions) is set too sensitively • The time selected for „FLOATINGDISPLAY“ is unsatisfactory
Configuration menu cannot be changed	<ul style="list-style-type: none"> • The password lock is activated in the configuration menu
The display flashes continuously during calibration	<ul style="list-style-type: none"> • The balance location is not stable enough (Interrupt calibration with «ON/OFF» and re-locate the balance in a better position) • Use of an imprecise calibration weight (only applies to external calibration)

17 Menu trees

17.1 Configuration menu tree

• LANGUAGE	
LANGUAGE	ENGLISH
SPRACHE	DEUTSCH
LANGUE	FRANCAISE
• UNIT-1	
UNIT-1	g mg kg ... Bht
• SET DATA PRINT	
AUTOSTART	ON/OFF
MODE	UNSTABLE STABLE LOADCHANGE CONTINUOUS TIMEBASE
TIMEBASE	2.0
SET PRINTFORMAT	DATE AND TIME ON/OFF BALANCE-ID ON/OFF PRODUCT-ID ON/OFF GROSS AND TARE ON/OFF UNITS ON/OFF OPERATOR-ID ON/OFF LINEFEED OFF/1/2/..9/FORMFEED
PRODUCT	ttt...
PRODUCTMODE	HOLD DELETE COUNT
OPERATOR	ttt...
• SET CALIBRATION	
MODE	OFF EXTERNAL EXT.-DEF. INTERNAL AUTO
DEF.	0.000 g
AUTOCAL.	TIME/TEMP. TEMPERATURE TIME
AUTOCAL.-TIME	6 h
AUTO-WARNING	ON/OFF
REPORT	ON/OFF
• SET WEIGHING MODE	
FLOATINGDISPLAY	0.08 0.16 0.32
STABILITY	LOW MEDIUM HIGH
AUTO-STANDBY	OFF 0.5 MIN 1 MIN 5 MIN 10 MIN
AUTO-ZERO	ON/OFF
QUICK-TARE	ON/OFF
ZERO-RANGE	0.000 g

• SET INTERFACE			
	BAUDRATE	300 600 1200 2400 4800 9600 19200 38400 57600	
	PARITY	7-EVEN-1STOP 7-ODD-1STOP 7-NO-2STOP 8-NO-1STOP 8-EVEN-1STOP 8-ODD-1STOP	
	HANDSHAKE	NO XON-XOFF HARDWARE	
	PC DIRECT MODE	ON/OFF	
	CHARACTER SET	ENG GER FRA	
	FORMAT	LINES TABLE	
	• SET DATE AND TIME		
	TIME	[HH.MM.SS]	
	DATE	[DD.MM.YY]	
	FORMAT	STANDARD/US	
• PASSWORD			
PASSWORD	----	DATA-PROTECTION	OFF MED HIGH
		NEW PASSWORD	- - - -
• THEFTCODE			
THEFTCODE	----	THEFT-PROTECTION	ON/OFF
		NEW CODE	- - - -
• KEY TONE			
KEY TONE	ON/OFF		
• BUS			
BUS	ON/OFF		

■ 17 Menu trees

17.2 Application menu tree

• SET APP.	
	OFF
	UNITS
	COUNT
	PERCENT
	NET-TOTAL
	ANIMAL
	DENSITY
	DIAGNOSTICS
• SETUP APPLICATION	
• AUTO-START	
AUTO-START	ON/OFF

Division depends on the current application, Chapter 12 "Working with the application menu".

17.3 User menu tree - to save or load settings

«MODE»- and «O/T»- button pressed on switching on:

LOAD FACTORY CONFIG.	Load factory-configuration.
LOAD USER CONFIG.	Load user-configuration.
STORE USER CONFIG.	Store present configuration as user-configuration.